



TAJ Carat and Gold Series

Portable Electronic Jewelry Balances



Designed for Basic Weighing in Jewelry Applications

The OHAUS TAJ Series was designed for precision portable weighing for a wide range of jewelry applications. From the Carat Series with high precision and a quick-open draftshield to the Gold Series for higher capacity weighing of precious metals and stones, the TAJ is a great value for your basic weighing needs.

Standard Features Include:

- **Superior Draft Protection** – The TAJ Carat balance was designed with an easy to open draftshield that provides protection to the weighing process while maintaining weighing speed.
- **USB or RS232 Connectivity** – The TAJ was designed with easy-to-install interface options for weight output to an OHAUS printer or PC.
- **Portable Battery or AC Power Operation** – Uses 4 “AA” batteries (not included) with auto shut-off, or can be run on the included AC powerpack.

TAJ Series Portable Jewelry Balances

Specifications

Model	TAJ203	TAJ202	TAJ602	TAJ501	TAJ4001	TAJ6000
Capacity	200 ct	200 g	600 g	500g	4000 g	6000 g
Readability	0.005 ct	0.01 g		0.1 g		1 g
Repeatability (Std. dev.)	0.015 ct	0.01 g		0.1 g		1 g
Linearity	±3d	±1d	±2d	±1d		
Span Mass	20 g*	200 g	300 g		2000 g	3000 g
Linearity Mass	20 g	100 g	300 g	300 g	2000 g	3000 g
	40 g	200 g	600 g	500 g	4000 g	6000 g
Weighing Units / Modes	Gram, grain, carat, ounce, ounce troy, pennyweight, kilogram ¹ , pound ² , Taels Hong Kong, Taels Taiwan, Taels Singapore, Tola, Tical, parts counting (with APW enhancement)					
Tare Range	To capacity by subtraction					
Stabilization Time	within 3 seconds					
Power Requirements	AC Adapter (included) or 4 AA Batteries (not included)					
Operating Temperature Range	50° - 104°F / 10° - 40°C at 30% - 90% relative humidity					
Pan size	3.9 in / 10 cm dia.	5.4 x 5.5 in / 13.7 x 14.0 cm				

*Included with TAJ203 Balance

¹TAJ4001, TAJ6000 models only

²TAJ501, TAJ602, TAJ4001, TAJ6000 models only

Outline Dimensions

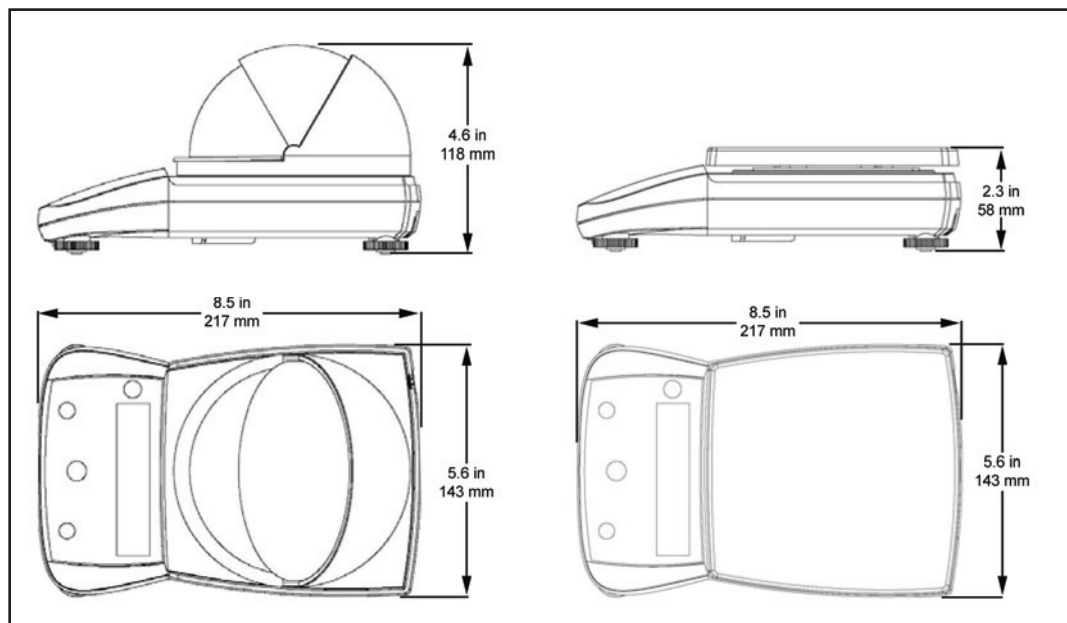

Standard Features

Additional standard features include weigh-below hook, integral transportation lock and calibration lock-out, rear security loop, programmable Auto Shut-Off, A/C adapter

Optional Accessories

	OHAUS Number
Secondary display with backlight.....	TAD7
RS232 communication accessory	83032107
USB communication accessory	83032108
Security device.....	76288-01
Calibration masses, printers, cables and other accessories.....	Contact OHAUS for Full Offering

Industry Leading Quality and Support

All OHAUS TAJ balances are manufactured under an ISO 9001:2008 Registered Quality Management System. Our rugged construction and stringent quality control have been hallmarks of all OHAUS products for over a century.

OHAUS CORPORATION

* 7 Campus Drive
Suite 310
Parsippany, NJ 07054 USA

Tel: 800.672.7722
973.377.9000
Fax: 973.944.7177

www.ohaus.com

With offices throughout Europe,
Asia, and Latin America

* ISO 9001

Registered Quality Management System

80774591_B © Copyright Ohaus Corporation

